

LAMMHULTS



TEIUS

MODULAR SEATING
DESIGN ANDRÉS NILSON

MÅNGSIDIGHET OCH ANPASSNINGSBARHET I KOMBINATION
MED DESS MÅNGA ANVÄNDNINGSMÖJLIGHETER ÄR STYRKAN
OCH KÄRNAN I TEIUS MODULMÖBEL.

Designer Andrés Nilson

VERSATILITY AND ADAPTABILITY COMBINED WITH ITS MANY
AREAS OF USE ARE THE STRENGTH AND CORE OF TEIUS
MODULAR SEATING.

Designer Andrés Nilson

Bänk H46 / Bench H46



Bänk H46 inkl. rygg och armlidare / Bench H46 incl. back and armrests.



Bänk H50 inkl. rygg, sidobord och armlidare / Bench H50 incl. Back, side table and armrest.













TEIUS

Pelarestativ av strukturpulverlackerat stålrör, Ø 40mm, med pressgjuten fot av återvunnen strukturpulverlackerad aluminium alt. polerad mot tillägg. Profiler i svart extruderad aluminium. Sits och rygg av plywood och skuret kallsaum.
Klädsel: Tyg/Läder

Tillval:

Polerad fot

Armstöd, strukturpulverlack

Armstöd med uppresningsstöd, strukturpulverlack

Kopplingsbord i 12 mm, vit eller svart, kompaktlaminat:

- kvadratisk 45x45cm

- 60°

- 90°

Ståbord, 120x33, 16 mm ask natur alt. vit eller svart bet med strukturpulverlackerat stativ. (Går ej kombinera med 120cm bänk inkl rygg.)

Sidobord Ø30 i 12 mm vit eller svart kompaktlaminat med strukturpulverlackerad arm

Koppling rygg mot rygg

Väggdistans

Golvinfästning

—

TEIUS

Pillar base of texture powder coated steel tubing, Ø 40mm, with foot of texture powder coated cast aluminum alt. polished against additional cost. Profiles in black extruded aluminum. Seat and back in plywood with high resilient polyurethane foam. Upholstery: Fabric/Leather

Options:

Polished aluminum foot

Armrest, texture powder coated

Armrest with raising aid, texture powder coated.

Connecting table in 12 mm white or black compact laminate:

-square 45x45

-60°

-90°

Stand table, 120x33, 16 mm ash veneer, natural or stained in white or black with texture powder coated frame. (Not in combination with bench 120cm incl. back)

Side table Ø30cm in white or black compact laminate with texture powder coated arm.

Linking device back to back.

Wall spacer.

Floor anchor.

TEIUS

Säulenuntergestell aus strukturpulverlackiertem Stahlrohr, Ø 40 mm, mit Fuß aus recyceltem Aluminium, strukturpulverlackiert alt. poliert gegen Aufpreis. Profile aus schwarz stranggepresstem Aluminium. Polsterung: Stoff/Leder.

Optionen:

Polierter Fuß

Armlehne, strukturpulverlackiert

Armlehne mit aufrechter Auflage, strukturpulverlackiert

Verbindungstisch aus 12 mm weißem oder schwarzem Kompaktlaminat:

-Quadratisch 45x45cm

-60°

-90°

Stehtisch, 120x33, 16 mm aus Asche natur oder gebeizt, weiß oder schwarz mit strukturpulverlackiertem Gestell. (Nicht in Kombination mit Bank 120cm inkl. Rücken)

Beistelltisch Ø30 aus 12 mm weißem oder schwarzem Kompaktlaminat mit strukturpulverlackiertem Arm

Verbindung Rücken an Rücken

Wandabstand

Bodenbefestigung

—

TEIUS

Colonne du piétement en tube d'acier, Ø 40mm, laqué époxy texturé, avec pied en aluminium moulé laqué époxy texturé ou poli à un coût supplémentaire. Profils en aluminium extrudé noir. Assise et dossier en contreplaqué avec mousse polyuréthane haute résilience. Revêtement: tissu/cuir

Options:

Pied en aluminium poli

Accoudoir, laqué époxy texturé

Accoudoir avec aide d'appui, laqué époxy texturé.

Table de raccordement en stratifié compact blanc ou noir, 12 mm:

-carré 45x45

-60°

-90°

Table haute, 120x33, 16 mm placage de frêne, naturel ou teinté blanc ou noir avec structure laqué époxy texturé.

(Pas en combinaison avec banc 120cm avec dossier.)

Table d'appoint Ø30cm en compact blanc ou noir, 12 mm, avec bras laqué époxy texturé.

Liaison des poutres dos à dos.

Entretoise murale.

Ancrage au sol.

TEIUS

Ellister:

2 USB + 1 el Schuko standard, sladdlängd 1.25m
2 + 2 USB Schuko standard, sladdlängd 1.25m
1 + 1 el Schuko standard, sladdlängd 1.25m

2 USB + 1 el UK standard
1 el + 1 el UK standard

2 USB + 1 el schweizisk standard
1 el + 1 el schweizisk standard

2 USB + 1 el fransk standard
1 el + 1 el fransk standard

—

TEIUS

Power and charging ports:

2 USB + 1 power outlet Schuko standard, 1.25m cable
2 + 2 USB Schuko standard, 1.25m cable
1 + 1 power outlet Schuko standard, 1.25m cable

2 USB + 1 power outlet UK standard, 0.2m + 2.0m cable
1 + 1 power outlet UK standard, 2.0m cable

2 USB + 1 power outlet Swiss standard, 0.2m cable
1 + 1 power outlet Swiss standard, 0.2m cable

2 USB + 1 power outlet French standard, 0.2m cable
1 + 1 power outlet French standard, 0.2m cable

TEIUS

Strom- und Ladestationen:

1 Steckdose Schuko Standard + 2 USB, Kabel 1.25m
2 + 2 USB, Kabel 1.25m
1 + 1 Steckdose Schuko Standard, Kabel 1.25m

2 USB + 1 Steckdose UK standard, Kabel 0.2m + 2.0m
1 + 1 Steckdose UK standard, Kabel 2.0m

2 USB + 1 Steckdose Schweizerisch standard, Kabel 0.2m
1 + 1 Steckdose Schweizerisch standard, Kabel 0.2m

2 USB + 1 Steckdose Französisch standard, Kabel 0.2m
1 + 1 Steckdose Französisch standard, Kabel 0.2m

—

TEIUS

Ports d'alimentation et de charge:

1 prise de courant standard Schuko + 2 USB, 1.25m câble
2 + 2 USB standard Schuko, 1.25m câble
1 + 1 prises de courant standard Schuko, 1.25m câble

2 USB + 1 prise de courant standard UK, 0.2m + 2.0m câble
1 + 1 prise de courant standard UK, 2.0m câble

2 USB + 1 prise de courant standard suisse, 0.2m câble
1 + 1 prise de courant standard suisse, 0.2m câble

2 USB + 1 prise de courant standard française, 0.2m câble
1 + 1 prise de courant standard française, 0.2m câble



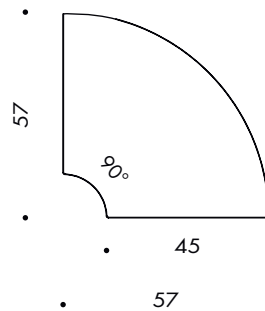
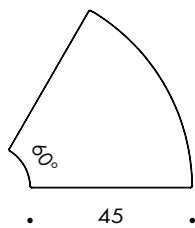
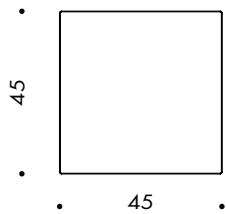
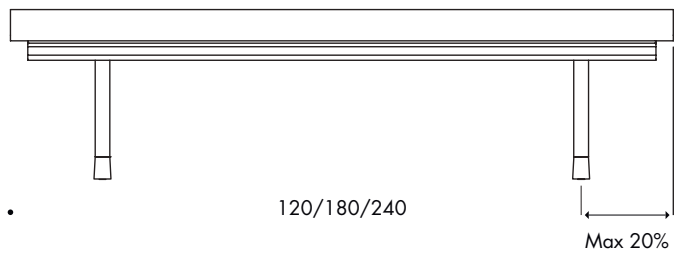
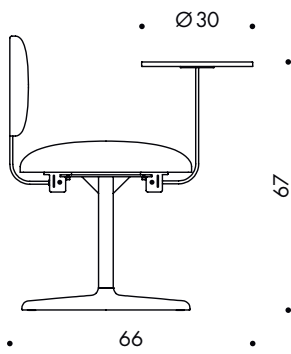
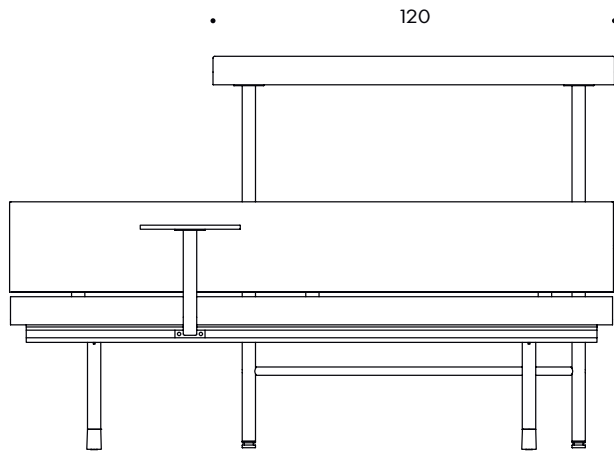
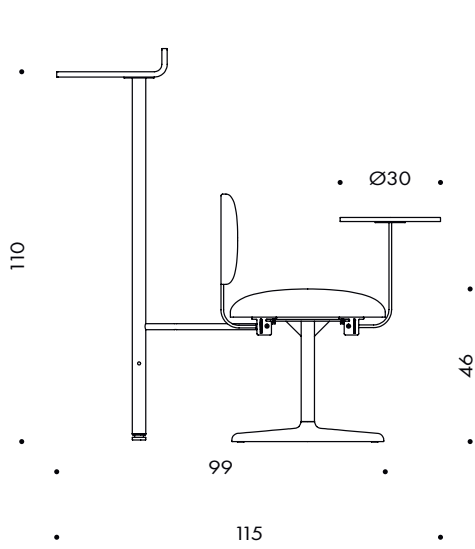
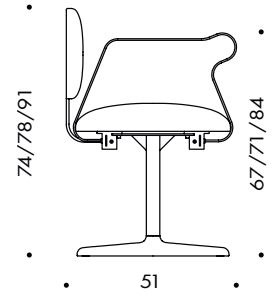
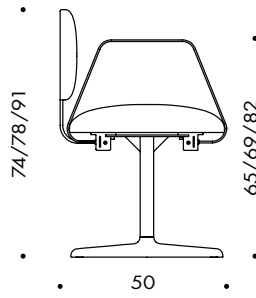
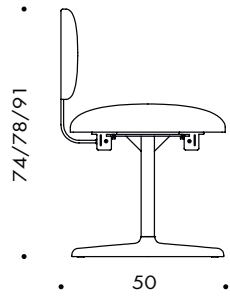
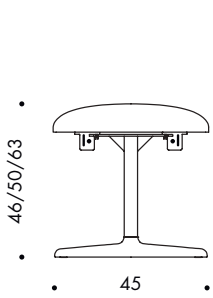

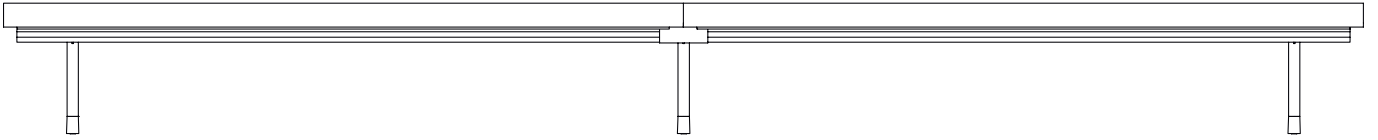
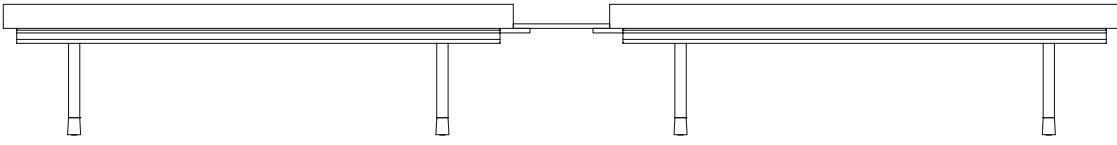

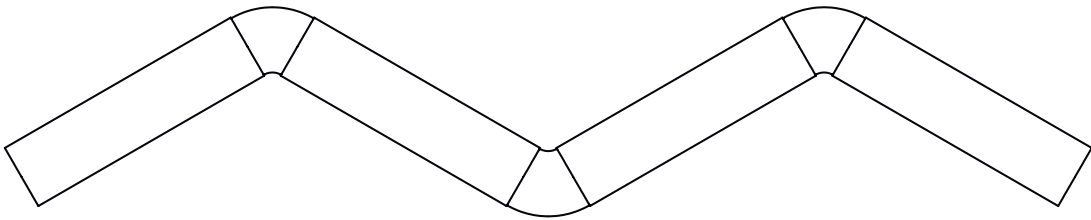
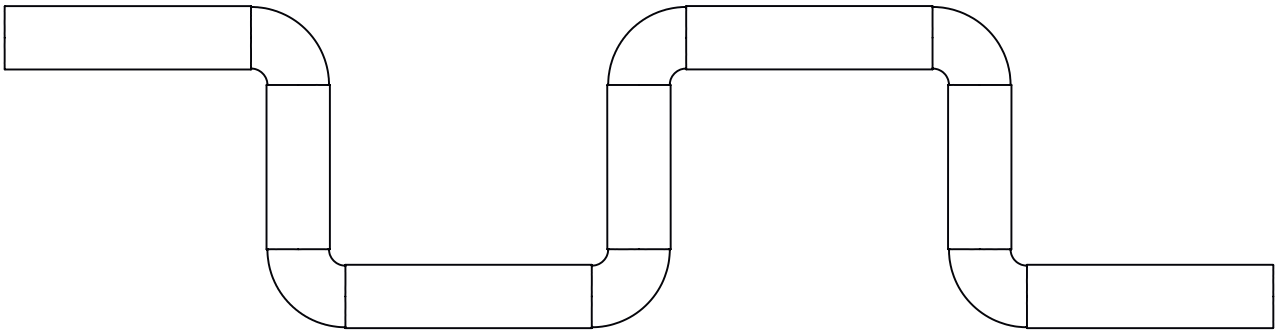
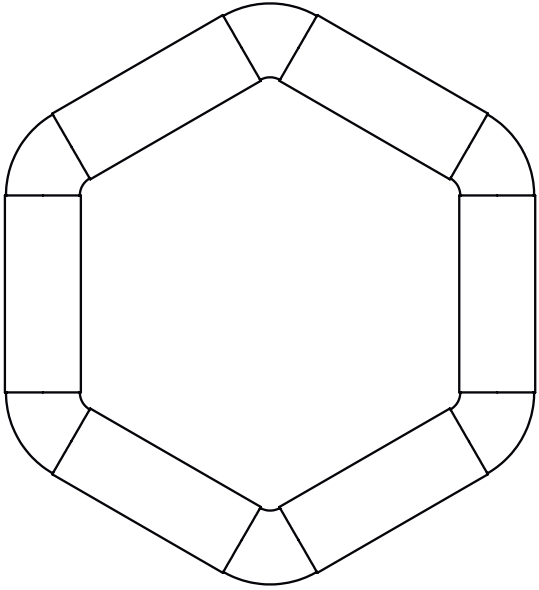
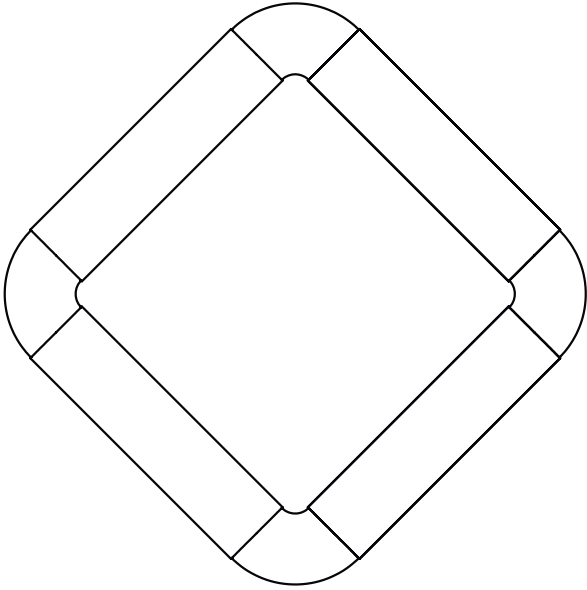

TEIUS

MODULAR SEATING
DESIGN ANDRÉS NILSON

Lammhults Möbel AB
Växjövägen 41, Box 26
SE-363 03 Lammhult
Sweden

CONTACT

+46 472 26 95 00
info@lammhults.se

www.lammhults.se

LAMMHULTS

LAMMHULTS OCH MILJÖN

För att minska resursförbrukningen och påverkan på miljön arbetar Lammhults med tidlös design för långt produktliv. Vi utvecklar och producerar produkter från material som har minsta möjliga miljöpåverkan och inte resulterar i restprodukter utan kan material- eller energiåtervinnas. Vi strävar efter att förhindra utsläpp i alla våra processer och arbetar med att successivt reducera miljö- och klimatmässiga fotspår från vår produktionslinje. Lammhults är certifierat enligt ISO 14001 sedan 1998 och fortsätter att arbeta kontinuerligt med miljöfrågor för att försäkra minsta möjliga miljöpåverkan.

LAMMHULTS AND THE ENVIRONMENT

To reduce the consumption of resources and the environmental impact, Lammhults work with timeless designs for long product life. We develop and produce products from materials that have the least possible environmental impact and do not result in waste but can be recycled as materials or energy. We strive to prevent pollution in all of our processes and work to successively reduce the environmental and climate footprint of our production facilities. Lammhults is certified according to ISO 14001 since 1998 and continues to work with environmental issues to ensure the least possible environmental impact.